

NORDKAPP

tritaggiaccio ice crushers



- Spacca ghiaccio professionale, strumento indispensabile nel bar per la preparazione di drink e frozen, e nel ristorante per l'esposizione di pesce o pietanze fresche.
 - Riduce in scaglie qualsiasi cubetto di ghiaccio prodotto da fabbricatore fino ad una misura di mm 40x40 a -3°C.
 - Previsto di regolazione sullo scarico, permette di gestire la grandezza media delle scaglie
 - Corpo macchina in alluminio estruso, bicchiere in acciaio inox, bocca di lavorazione in ABS alimentare e coltelli ghiaccio in acciaio.
 - Motore ventilato con trasmissione ad ingranaggi, per un servizio prolungato, micro interruttore sul coperchio per la massima sicurezza dell'operatore.
- Professional ice crusher, an indispensable bar tool for preparing drinks and frozen cocktails and in the restaurant for displaying fish or fresh foods.
 - Crushes any ice cubes made with an ice cube machine up to 40x40mm at -3° C.
 - Its discharge adjustment lets you regulate the average size of the crushed ice.
 - Extruded aluminium body, stainless steel container, food-grade ABS opening and s/steel blades.
 - Ventilated motor with gear transmission for prolonged use, micro-switch on the lid for maximum operator safety.









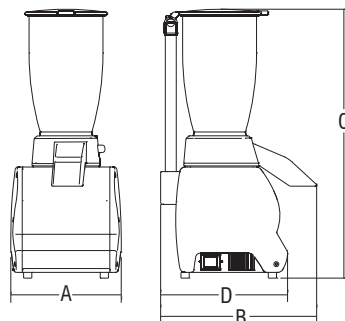





Leva per la regolazione dello spessore del ghiaccio
Adjustable lever ice thickness



Coltelli
Blades



| |  |  |  |  |  |  |  |  |  |  |  |  |
|-----------------|---|---|---|---|---|---|---|---|--|---|---|---|
| | watt | 1ph | r.p.m. | lt | lt | mm | mm | mm | mm | kg | mm | kg |
| Nordkapp | 150 | 1ph | 800 | 3 | 2 | 205 | 285 | 491 | 235 | 5.2 | 410x280x560 | 8 |



Distributor:

KiD Catering Equipment, Oaktree Court Business Centre, Mill Lane, Ness, Cheshire, CH64 8TP
Tel: 0333 123 2450

sales@kidcateringequipment.com

 SIRMAN