



## ■ ■ **BRILLIANT AND CONVINCING**

are the **bar tops** in stainless steel from HAGOLA

- ■ exceptionally hygienic due to the unique prism drip plates
- ■ intelligent use of the available space for a larger work surface
- ■ the ideal equipment for bar and counter areas





# ❑ ONLY AVAILABLE FROM HAGOLA: PRISMS

Exclusive »First Class«-bar tops with unique prism drip plates

Discover our standard bar tops or made-to-measure products:

- ❑ available in different lengths ex our warehouse
- ❑ individual made-to-measure products on request



Bar top with deep-draw

Larger working and rinsing surface:



with unique prism drip plates



overflow pipe with valve, both in stainless steel



larger working and rinsing surface due to minimised edges



beer froth drains off, hygiene advantage, brilliant look

**The »First Class«-versions of the bar tops are only available from HAGOLA.**

Minimised distances to the sinks and to the waiter side provide for a hygiene-safe working, larger depressions with the unique prism drip plates offer up to 100 % more storage area than common drip depressions – but above all a hygienic surface.

Index:

<b>Bar tops (HSD)</b> .....	4
<b>Bar cover tops (HSA)</b> .....	6
<b>Top drip trays (HAS)</b> .....	8
<b>Built-In Drip Trays – top side assembly (HES)</b> .....	9
<b>Built-In Drip Trays – bottom side assembly (HUS)</b> .....	9
<b>Prism grids (HPR)</b> .....	11
<b>Prism drip plates (HPL)</b> .....	11
<b>Prism decor plates (HPD)</b> .....	11



# BAR TOPS

»First Class«-bar tops, the standard for bar counter sections

## Your product advantages:

- in stainless steel (1.4301) brushed surface
- dispensing bed and drip depression incl. prism drip plates
- your choice: with 1 or 2 sinks, on left or right side
- upward edge (660 mm deep) or surrounding downward edge (700 mm deep)
- as option: glass pressure rinser and drip depression rinsing

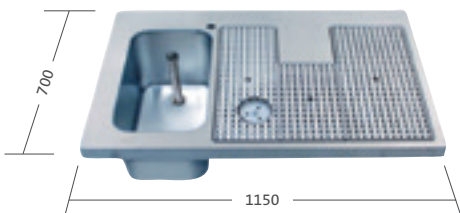

only available in version: »1 sink on left side«

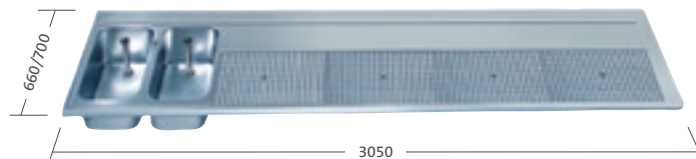
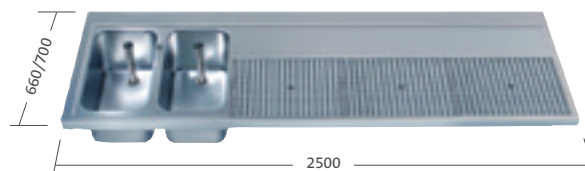
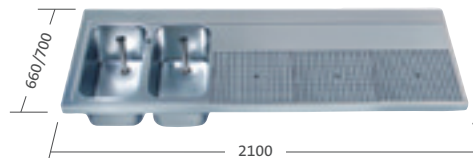
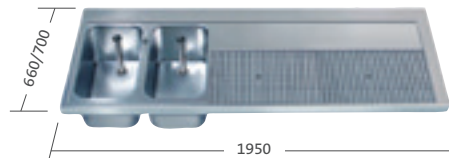

## Bar tops with work surface or with depression for dishwasher racks

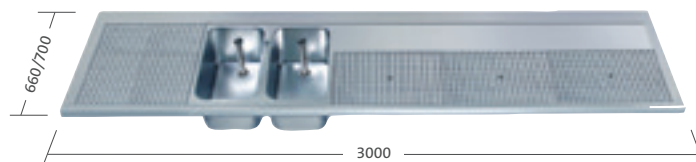
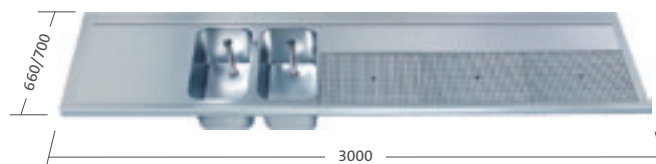
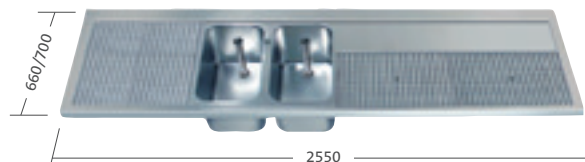
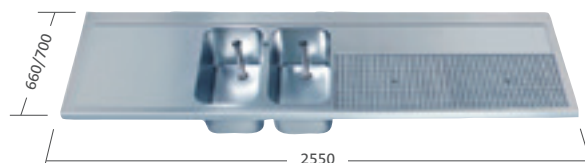
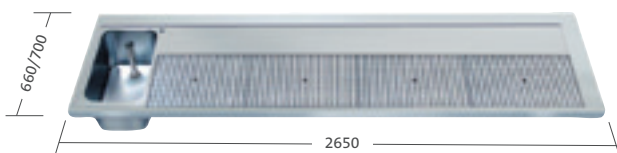
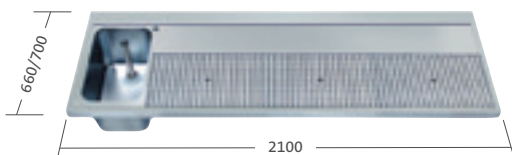
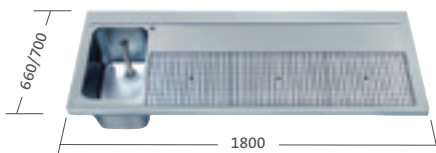
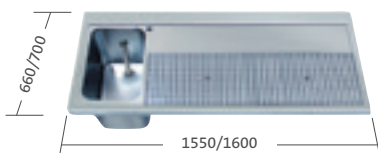

Individual made-to-measure products on request

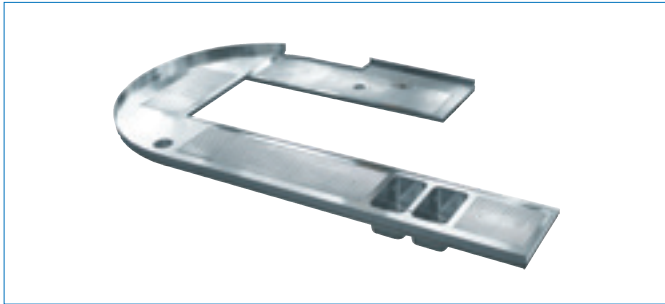
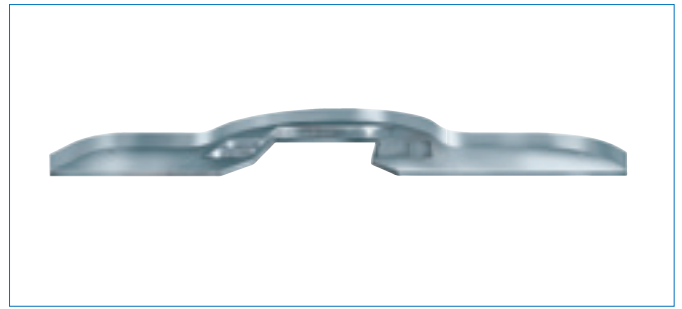
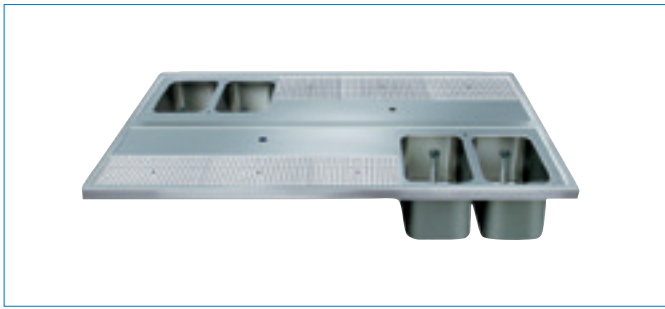

Accessories:



detergent dispenser

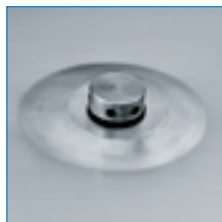

drip depression rinsing

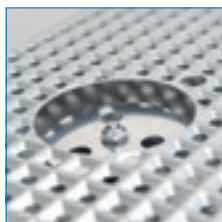

glass pressure rinser

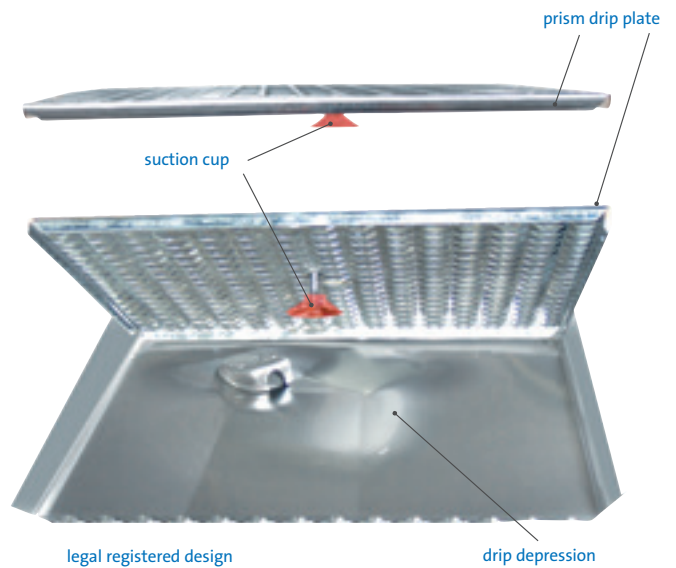

Suction cup for fixing the prism drip plates is used for mobile sectors.

# BAR COVER TOPS

with ribbed drainage surface

## Your product advantages:

- in stainless steel (1.4301) brushed surface
- lowered bulge border as surrounding drain gutter
- ribbed drainage surface with column base
- your choice: with 1 or 2 sinks, on left or right side
- upward edge (660 mm deep) or surrounding downward edge (700 mm deep)
- as option: glass pressure rinser and pouring drain



overflow pipe with valve, both in stainless steel



larger working and rinsing surface due to minimised edges



lowered bulge border with surrounding downward edge and drain gutter

## Models:

with pouring drain and glass pressure rinser

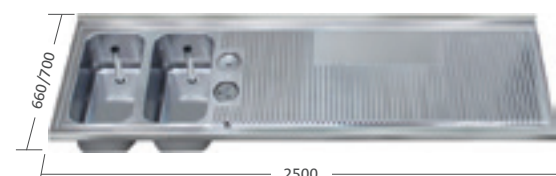
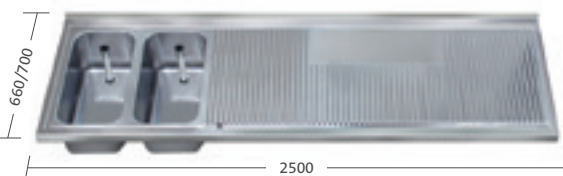
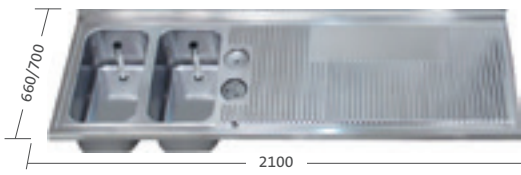
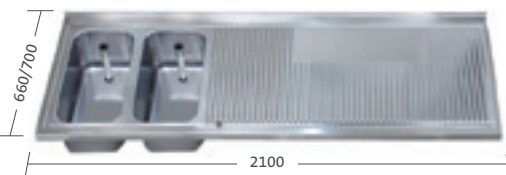
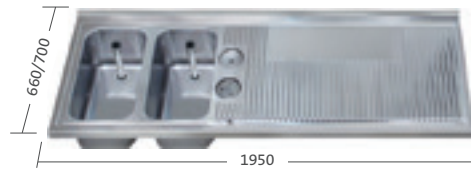
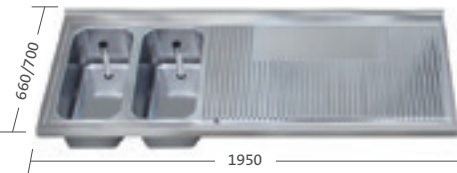
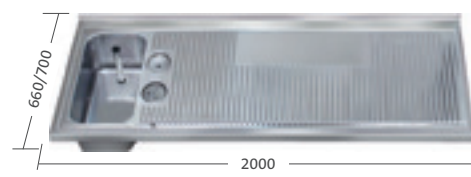
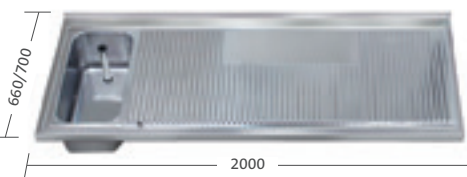
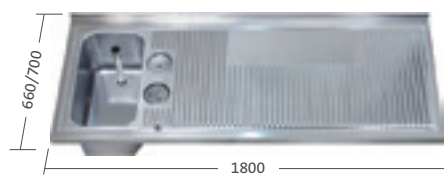
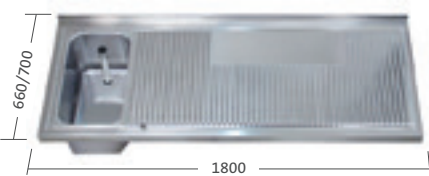
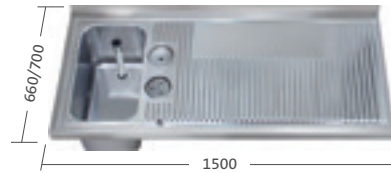
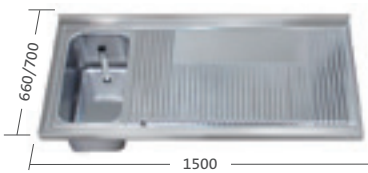



Individual made-to-measure products on request

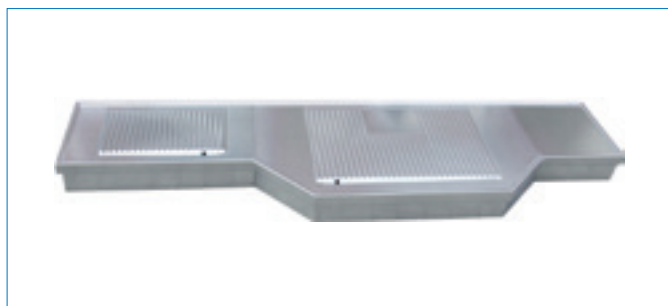

**Accessories:**

glass pressure rinser



pouring drain





### Drip trays from HAGOLA

With their brilliant look, the drips trays from HAGOLA – whether the table-top model or as built-in version, whether the bottom or top side assembly – are made of stainless steel (1.4301) and are the optimal completion for work surfaces in the bar area. The unique prism drip plates in high-gloss finished stainless steel (1.4301) guarantee an easy cleaning and thus, are very hygienic.

Depending on the intended use and the necessary requirements, the customer can choose the drip tray that optimally matches with his furnishings – even for retrofitting or as complement.

## TOP DRIP TRAYS

in brushed stainless steel / with prim drip plate(s) / high-gloss finished

### Your product advantages:

- in stainless steel (1.4301) brushed surface
- prism drip plate(s), high-gloss finished
- without drain
- deep-drawn feet
- everywhere and immediately ready for use



#### LxWxH

210 x 210 x 33 mm	420 x 210 x 33 mm
280 x 140 x 33 mm	490 x 280 x 33 mm
280 x 210 x 33 mm	560 x 210 x 33 mm
420 x 140 x 33 mm	700 x 210 x 33 mm



# == BUILT-IN DRIP TRAYS (TOP SIDE ASSEMBLY)

to be installed very easy and quickly / even for retrofitting

## Your product advantages:

- == in stainless steel (1.4301) brushed surface
- == 20 mm surrounding supporting edge and prism drip plate(s), high-gloss finished
- == your choice: with drain on left or right side, even for a quick and easy retrofitting



cross section supporting plate / drip tray (top side assembly)

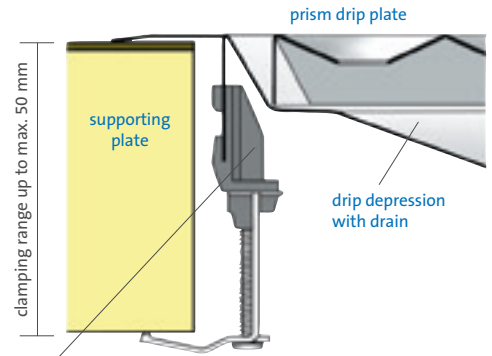

### L x W x H (incl. 20 mm supporting edge)

460 x 250 x 32 mm	460 x 460 x 32 mm
600 x 320 x 32 mm	530 x 530 x 32 mm
1020 x 320 x 32 mm	600 x 600 x 32 mm

screwable fastening clamps (enclosed but unmounted delivery)

# == BUILT-IN DRIP TRAYS (BOTTOM SIDE ASSEMBLY)

for a flush installation

## Your product advantages:

- == in stainless steel (1.4301) brushed surface
- == 20 mm surrounding supporting edge and prism drip plate(s), high-gloss finished
- == your choice: with drain on left or right side
- == flush installation of the prism drip plate, e.g. under mineral-based plates

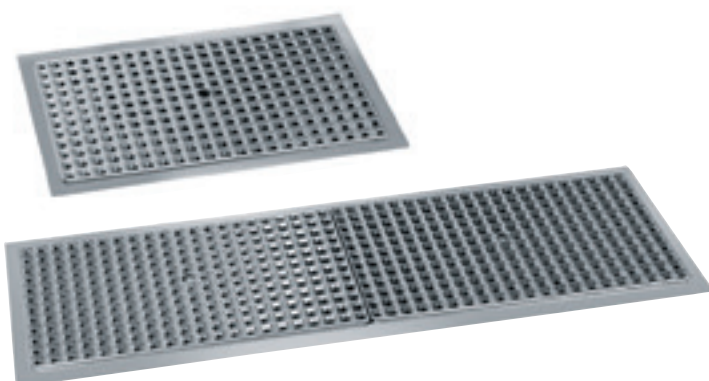

cross section supporting plate / drip tray (bottom side assembly)

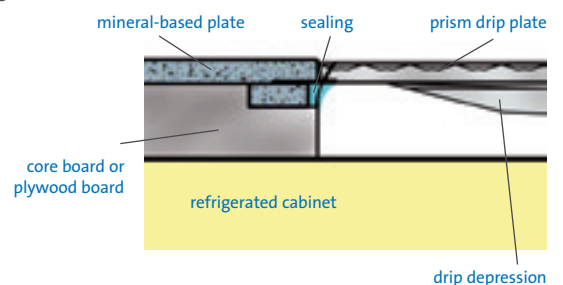

### L x W x H (incl. 20 mm supporting edge)

530 x 320 x 22 mm	1020 x 320 x 22 mm
-------------------	--------------------





## PRISM GRIDS

with rubberised feet, to be used as additional storage surface for glasses

### Your product advantages:

- in high-gloss finished stainless steel (1.4301)
- 10 mm surrounding downward edge
- with anti-slip, scratch-resistant and rubberised legs
- can be used immediately and everywhere

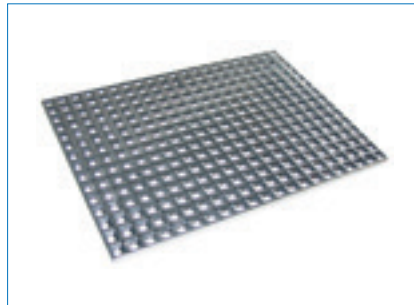

## PRISM DRIP PLATES

with finger hole for easy lifting

### Your product advantages:

- in high-gloss finished stainless steel (1.4301)
- 10 mm surrounding downward edge
- can be used as shelf plates for instance
- insert and replacement for HAGOLA-drip depressions

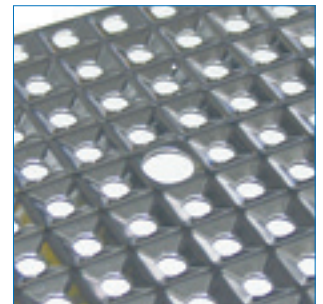

## PRISM DECOR PLATES

with or without fastening drill holes

### Your product advantages:

- in high-gloss finished stainless steel (1.4301)
- 10 mm surrounding downward edge
- can be used as shelf plates or panelling for instance
- sets brilliant effects
- modern decoration



## Your **HAGOLA**-advantages

- :: **Competent** advice
- :: **2-years manufacturers guarantee** on material
- :: **ISO-certified** in accordance with DIN EN ISO 9001 – highest quality guaranteed!
- :: **Yearly** product seminars and trainings
- :: **Best raw materials** – we rely on brand-name products like Danfoss, Störk-Tronic and Thyssen-Krupp.
- :: **Weekly, packaging-free delivery** with our HAGOLA-own truck service (only throughout Germany)
- :: **Service partner network** incl. service hotline – 24/7 available for you – dial +49 4444 201120
- :: **All from one source** – discover our variety!

- :: **Refrigerated Bar Counters**
- :: **Cocktail Stations**
- :: **Display Cases**
- :: **Show Cases**
- :: **Cooling Tubs**
- :: **Meat Counters**



**HAGOLA Gastronomie-Technik GmbH & Co. KG**  
Hagolastraße 2 · 49424 Goldenstedt | Germany  
Phone: +49 4444 201-0 · Fax +49 4444 201-111  
info@hagola.de · www.hagola.de

Technical modifications reserved.

Consultation | Sale | Service