

EVOX 20/40 - 200kg Roll-in



TECHNICAL FEATURES

Model	Performance		Capacity in Trays	Standard Tension	Power Consumption	Refrigerant
	(+90°C/+3°C)	(+90°C/-18°C)				
SQXW20FT.200	200 kg	130 kg	40GN 1/1 40EN 60x40	400V / 3Ph+N 50Hz	10,0 kW 31,0 A	R404A 5,000 kg
SQXW20FT.200W						R404A 0,000 kg
SQXW20FT.200SG *	/	/	20GN 2/1 20EN 60x80	230V / 1Ph 50Hz	0,9 kW 5,0 A	CO ₂ 0,000 kg
SQXW20FT.200SGCO ₂						

* Appliances without unit (for centralized cooling systems) are also available for R448A or R449A refrigerant - upon request

CONSTRUCTIVE FEATURES

	STRUCTURE IN STAINLESS STEEL AISI 304 18/10 - EXTERNAL: SCOTCH BRITE, INTERIOR: MIRROR FINISHING		ROUNDED INNER AND OUTER ANGLES CLEANING AND SPACE UNDER THE EVAPORATOR FOR A PERFECT AND EASY CLEANING
	CERTIFIED ITALIAN HIGH PERFORMANCES REFRIGERATING UNITS		OVERSIZED CONDENSERS TO ENSURE RELIABILITY
	SPECIAL FANS SUITABLE FOR LOW TEMPERATURE WITH SPEED REGULATION SYSTEM		CATAPHORESIS PAINTED ANTI-CORROSION EVAPORATORS

Structure insulation in CFC-free polyurethane DPO-0 - Door frame completely integrated in the structure itself to grant top hygiene - Self-closing door equipped with a silicone gasket resistant to low temperatures, magnetic and heated door frame - Core probe with strong silicone gum grip as standard - Lateral drain hole for condensation and water run out - The technical room of evaporator and condenser can be easily inspected through a compass opening

The appliance is supplied without trays, without trolley, ramp and without mobile oven racks. CO2 versions are supplied without thermic expansion valve. The manufacturer reserves the right to carry out modifications of the product without notice. For different voltages and/or frequencies quotations on demand.

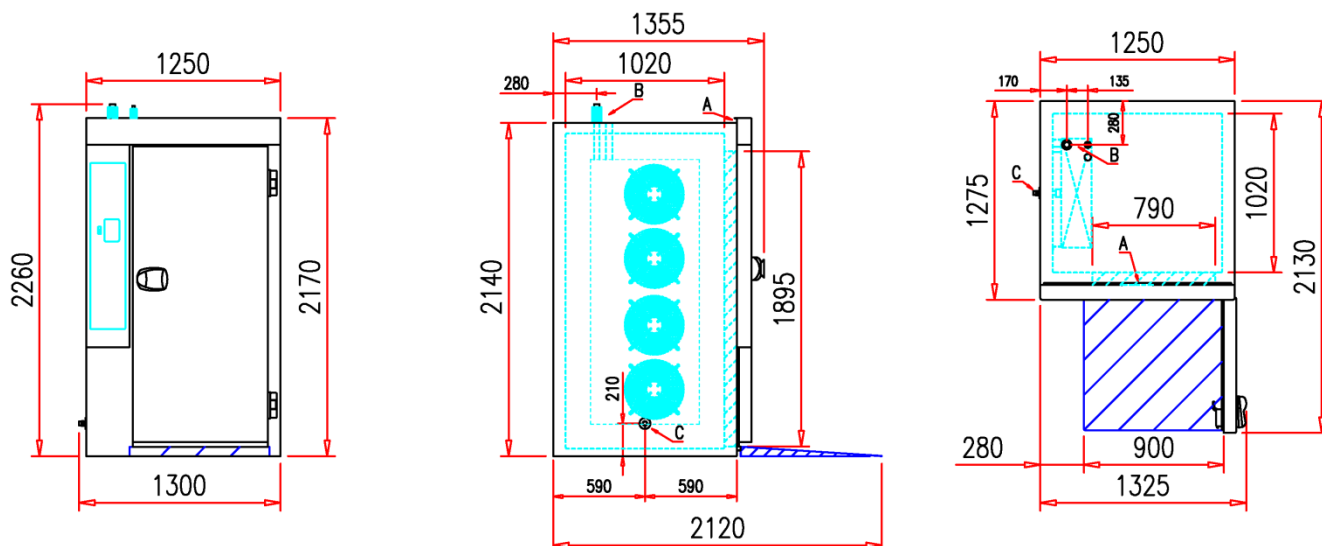

A = Electrical and Water connection (when needed)
 B = Refrigeration connection
 C = Evaporator water drain pipe

TECHNICAL DATA

Model	Refrigerating Power		Consumption kWh/kg		Net Weight	Insulation Thickness	Room Conditions	Certifications
	*Te = -10°C	*Te = -30°C	(+90°C/+3°C)	(+90°C/-18°C)				
SQXW20FT.200	25.500 W	10.600 W	0,10	0,29	295 kg (Cell)	80 mm	+32°C 60% UR	CE
SQXW20FT.200W					320 kg (Remote unit)			
SQXW20FT.200SG **			/	/	295 kg			
SQXW20FT.200SGCO ₂								

** Appliances without unit (for centralized cooling systems) are also available for R448A or R449A refrigerant - upon request

* Te = Expansion Temperature - Condensation Temperature = +45°C

ELECTRONIC CONTROLLER
Cycles available:

- Temperature blast chilling and conservation
- Time blast chilling and conservation
- Temperature deep freezing and conservation
- Time deep freezing and conservation
- Soft and hard cycles for both blast chilling and deep freezing
- Multi timer non-stop cycle
- Pre-cooling

Optional cycles:

- Multi core probe non-stop cycle
- Sterilization
- Leavening/proving
- Low temperature slow cooking



Special functions:

- Recipe book
- Automatic control on core probe insertion
- raw fish sanitation
- Thawing
- Manual defrost
- Special cycle for ice cream
- Drying
- Evaporator fan speed regulation
- USB

Optional functions:

- Core probe heating
- Multipoint core probe
- Multi core probe

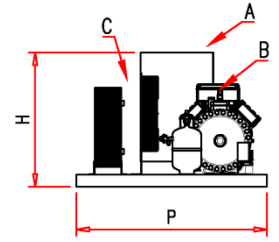
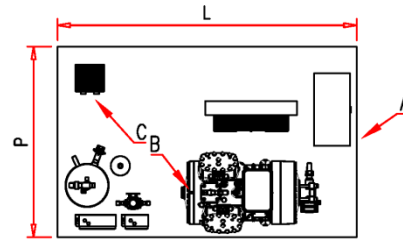
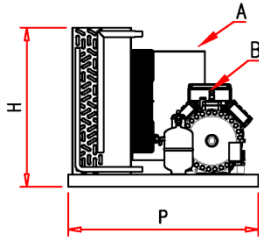
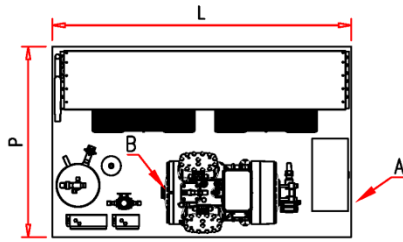
The appliance is supplied without trays, without trolley, ramp and without mobile oven racks. CO2 versions are supplied without thermic expansion valve. The manufacturer reserves the right to carry out modifications of the product without notice. For different voltages and/or frequencies quotations on demand.

EXTERNAL DIMENSIONS REMOTE UNIT
AIR-CONDENSED
WATER-CONDENSED (W)

A = Electric connections
 B = Refrigeration connection
 C = Water connection

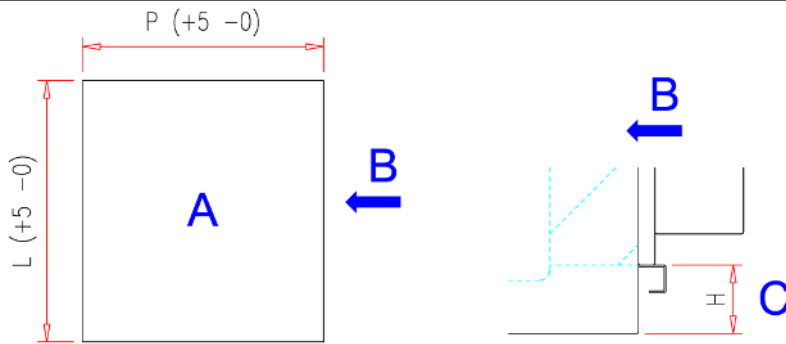
Width (L) = 1650 mm
Depth (P) = 1050 mm
Height (H) = 890 mm
FLOOR HOLE DIMENSIONS (CELL SUNK INTO THE FLOOR)

Width (L) = 1260 mm
Depth (P) = 1215 mm
Height (H) = 62 mm

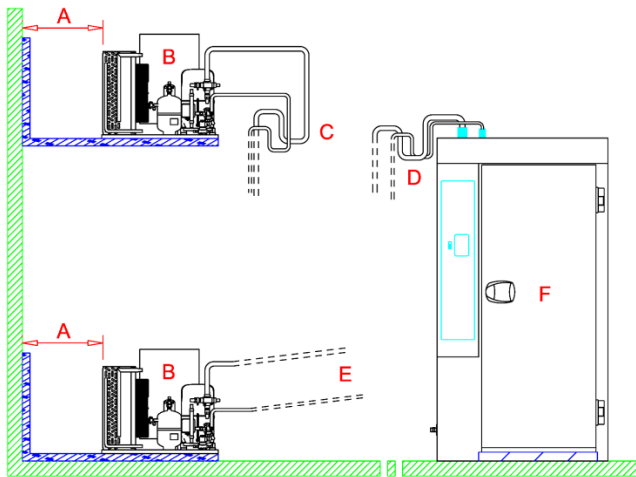
A = Hole dimensions
 B = Door - Trolley entrance
 C = Hole height - Step height

REFRIGERATION CONNECTION

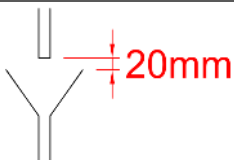
PIPES DIMENSIONS
Inlet = Ø 16 mm
Suction = Ø 42 mm
Inlet CO₂ = Ø 12 mm
Suction CO₂ = Ø 22 mm
Pipes installation for standard models

A = Minimum distance from the wall 1mt
 B = Remote unit
 C = To be executed every 2 meters in height
 D = Inlet and suction pipes
 E = Minimum slope 3mm /mt toward the remote unit

WATER CONNECTION











Minimum distance between water drain and floor or other surface.
 Use network water with a minimum pressure of 100 kPa and a maximum of 500 kPa;
 temperature shall not exceed + 18 ° C; do not use sea water, specific models are
 available upon request.

ELECTRIC CONNECTION

General Feeding Cable		Control Panel Feeding Cable (from remote unit to cell)	Connection Cable (from remote unit to cell) Standard
Standard	SG version		
5x10mm ² NPI	3x4mm ² NPI	3x4mm ² NPI	7x1,5mm ² NPI

The appliance is supplied without trays, without trolley, ramp and without mobile oven racks. CO2 versions are supplied without thermic expansion valve.
 The manufacturer reserves the right to carry out modifications of the product without notice. For different voltages and/or frequencies quotations on demand.

ACCESSORIES (OPTIONAL)

	Leavening and Slow cooking	ACC FO8		Led light	ACC 149
	Ramp (1 piece)	ACC 181		Left opening door	ACC 136
	Ozone Sterilizer	ACC 110		Heated Core Probe	ACC 509
	Multipoint core probe	ACC 510		Trolley with castors 20 GN 2/1	ACC 167
	Silenced cover for external use	ACC 190.200		Trolley with castors 20 EN 60x80	ACC 170

DATA SHEET ACCORDING TO prEN 17032

Model	Product Type	Refrigerating Gas			Program	
		Type	GWP	Charge	Blast Chilling	Deep Freezing
SOXW20FT.200	BLAST CHILLER DEEP FREEZER	R404A	3922	5,000 kg	HARD	TIME
SOXW20FT.200W				0,000 kg	/	/
SOXW20FT.200SG *		CO ₂	1			
SOXW20FT.200SGCO ₂						

* Appliances without unit (for centralized cooling systems) are also available for R448A or R449A refrigerant - upon request

Model	Blast Chilling (+65°C / +10°C)			Deep Freezing (+65°C / -18°C)		
	Maximum Capacity	Energy Consumption E	Time t	Maximum Capacity	Energy Consumption E	Time t
SOXW20FT.200	200 kg	0,10 kWh/kg	120 min.	130 kg	0,29 kWh/kg	260 min.
SOXW20FT.200W						
SOXW20FT.200SG *	/	/	/	/	/	/
SOXW20FT.200SGCO ₂	/	/	/	/	/	/

* Appliances without unit (for centralized cooling systems) are also available for R448A or R449A refrigerant - upon request

Manufacturer: A.T.O. S.R.L. - Via dell'Artigianato, 24 - 31030 Castello di Godego - Treviso - Italy

STANDARD PACKAGE

Package	External dimensions				m ³	Gross weight	
	Width	Depth	Height	Standard		SG Version	
1	1530 mm	1490 mm	2400 mm	5,47	380 kg	380 kg	
2	1720 mm	1100 mm	1080 mm	2,06	360 kg	/	

The appliance is supplied without trays, without trolley, ramp and without mobile oven racks. CO2 versions are supplied without thermic expansion valve. The manufacturer reserves the right to carry out modifications of the product without notice. For different voltages and/or frequencies quotations on demand.